

# Star of Bethlehem

*"Abiding in Christ, Loving as Christ, Inviting to Christ"*

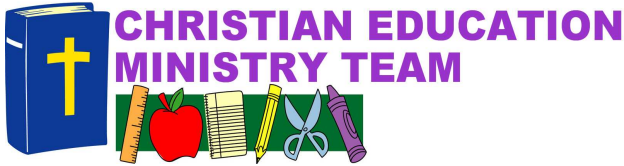

January 2011



## CHRISTIAN EDUCATION MINISTRY TEAM

2011 is already upon us and we have just finished up on a terrific 2010! We welcomed new leadership with Dr. T's arrival and the blessings that God sent with him! He has energized the people and lightened-up the pulpit with his sermons filled with characterizations and humor! We also welcomed Andy to a new responsibility here at Bethlehem as he became our new Director of Christian Education! Andy has poured new life in our Sunday School curriculum and into the JAMS program! God is working through Andy and Dr. T. to bring His Word to all of us! But, God expects all of us to work to spread His word! What will you do in 2011 to help God? Be ready to serve!

Just because the season of giving gifts has already come and gone, it doesn't mean that we can't give "gifts" daily to others! Have you ever thought of giving someone the "gift of laughter"? What an easy gift to give by sharing a funny story or a silly little joke! What a wonderful way to connect with someone to let them know that you want to laugh with them. Our world can be much too serious if we listen to the news. Think Laughter! Think of all of the many blessings that God has bestowed upon us and that will surely bring a smile! Think Laughter! Keep that smile and let it get even wider! Laughter is so easy to come by and it's a great "gift"!

Another "gift" that you can give each day is the "gift of listening"! Everyone needs someone to truly listen to them. Listen to every word that they are saying without interrupting to tell something yourself. Be quiet and listen! Connect to someone today by really, really listening to what they are saying! Haven't you been talking to someone and their eyes wander off in another direction? They are not listening to you any more! If you truly listen to someone, you maintain eye contact for the entire conversation. Show that you care by "listening"! It is a gift to someone as well as a gift to you!

## Our first loyalty

The beginning of a new year is a good time to consider our compelling — and sometimes competing — loyalties. Our first loyalty must always be to our loving Creator. "You shall have no other gods before me," says the first commandment (Exodus 20:3, NRSV). Although other loyalties are important (family, country, work), God is the top priority.

The brilliant Christian statesman Thomas More tried to serve King Henry VIII well. But when the tyrant king made unethical demands on More that conflicted with God's standards, More refused to obey.

The terrible consequence was More's beheading. In 1535, just before the sharp blade fell on his neck, More proclaimed, "The king's good servant, but God's first."



The Elder Class of 2013 was installed on December 26, 2010.

Carolyn Gordon, Patsy Cuthbertson and Charles Greene.



Please pray for these folks as they begin their new ministries and responsibilities here at the church



*"Blessed is the one  
who comes in the name  
of the Lord."*

**LUKE 13:35, NRSV**

# January



SUNDAY	MONDAY	TUESDAY	WEDNESDAY	THURSDAY	FRIDAY	SATURDAY
						1 
2 JAMS – 6PM	3	4 Bible Study 10 am & 6:45 pm	5 7:00 pm – Presbyterian Women	6	7	8
9 JAMS 1 pm – Extreme Ice Center \$8.00 per person	10	11 Bible Study – 10am & 6:45pm  Session – 7:00 pm	12 11:00 am – Senior Lunch	13	14	15
16 JAMS 4 pm – Fellowship Hall	17	18 Bible Study – 10 am & 6:45 pm	19	20	21	22
23	24	25 Bible Study – 10 am & 6:45 pm	26 11:00 am Congregational Care MT	27	26	29
30	31					



Here at the start of 2011, I just want you to know: I don't just have good intentions (we all know where the road paved with those will lead!). I also have

**Pastor's Message**

big PLANS!

But then, I had some big plans when my feet hit the deck running here at Bethlehem last January 1. Some of the plans have come to fruition. But then there are others....

It seems that this past year a lot of surprise events that distracted, diverted, discouraged, and even distorted some of my best efforts! Yikes!

But I don't think I am the first to encounter such frustrations. God's Word says, *"Many are the plans in a man's heart, but the counsel of the Lord, it will stand."* (Prov. 19:21)

A crucial piece of info is that it is not primarily about MY plans, is it? His are ALWAYS better than mine. *"I know the plans that I have for you", declares the Lord, 'plans for welfare and not for calamity to give you a future and a hope.'* (Jeremiah 29:11)

I know I need to keep working hard, but there is that factor of keeping in mind just WHO is ultimately in charge. As James says, *"...you do not know what your life will be like tomorrow. You are just a vapor that appears for a little while and then vanishes away. Instead, you ought to say, 'If the Lord wills, we shall live and also do this or that.'"* (James 4:14-15)

God has the gifts of tomorrows which He bestows upon us until this realm intersects with eternity. Plan well. Work hard. Pray harder. And remember Who is really in charge. That's a reminder for me in this coming year. And I hope for you, too.

In Jesus,  
Dr. T



Great possibilities

"Happily for us, the fundamental Christian message concerns not what we ought to do but what God has done and what God is willing to do. In fellowship with him and with others who are likewise trying to be like him, we can be lifted up above our native possibilities."

—Hugh Martin



**January Birthdays...**

- 1st ...Leigh Anne Hrischenko, Robert Meyer
- 4th ...Betty Faulk
- 5th... Anthea Aldridge
- 7th... Jennifer Hrischenko
- 14th... Zachary Brame
- 16th... Andrew Brame
- 17th... Rachel Helms
- 18th... Chad Price
- 19th... Leigh Younce
- 20th... Eric Thomas
- 24th... Matthew Price
- 25th... Justin Brame
- 30th... Gaston Outen, Dennis Simpson

**If your birthday is not listed or if you are not sure we have your birthday, please call the church office so we can make sure we have it for the future!**



	<u>December 20, 2010</u>	<u>2010 Year-to-Date</u>
Actual	\$ 4,231.70	\$ 216,271.02
Budget	\$ 4,667.00	\$ 242,665.00
Difference	-\$ -435.30	-\$ -26,393.98



Once again the children did a splendid job acting and singing their way through the First Thanksgiving Program. There were around 60 in attendance and all enjoyed great fellowship and food together. Than you to all who helped prepare food, set up and clean up.

We immediately jumped into practice for the Christmas pageant to be presented on Thursday, December 16th. We will travel back to the first Christmas night with Mary and Joseph, shepherds, angels, kings and even a donkey! The children are also busy creating Christmas decorations and gifts along with their continuing academic work.

**Please note that we have a peanut allergy alert this year. If any group is using the preschool rooms remember to wash the tables and chairs when food is served and take out the trash.**

The Preschool wishes each one of you a Very Blessed Christmas and a Joyous New Year!

In Christ's love,  
Robin Graham

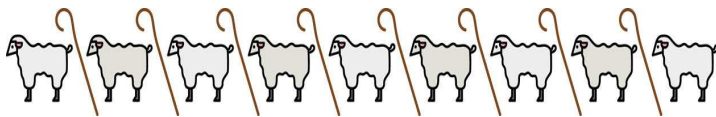

1/10/1970 .....Tom & Louise Crawford

**If your anniversary is not listed or if you are not sure we have your anniversary, please call the church office so we can make sure we have it for the future!**

## Volunteer Schedule

January 2011

January 2

8:45 Greeters: Tom & Anthea Aldridge  
8:45 Nursery: Kara & Zoe Lemon  
11:00 Ushers: Tilden Belk  
11:00 Nursery: Jan Haigler  
Open Church: Tom Aldridge  
Close Church: Tilden Belk

January 9

8:45 Greeters: The Brame Family  
8:45 Nursery: The McConnaughey Family  
11:00 Ushers: Louie & Nancy Brantley  
11:00 Nursery: Brenda Huntley  
Open Church: Scott Cuthbertson  
Close Church: Gerald Gaddy

January 16

8:45 Greeters: Robin Castorina  
8:45 Nursery: The Outen Family  
11:00 Ushers: Daphne Caldwell  
11:00 Nursery: Kerry & Jessie Price  
Open Church: B.B. Haigler  
Close Church: B.B. Haigler

January 23

8:45 Greeters: Ann Cuthbertson  
8:45 Nursery: Don & Ann Price  
11:00 Ushers: Tom & Louise Crawford  
11:00 Nursery: Lazette Thomas  
Open Church: Rex Hovey  
Close Church: Tommy & Judy Johnson

January 30

8:45 Greeters: Scott & Mary Ann Cuthbertson  
8:45 Nursery:  
11:00 Ushers: Bob & Amy Currie  
11:00 Nursery: Faye Vicars  
Open Church: Patricia Kindley  
Close Church: Ryan & Mary Knight

**\*\*Please Note: Please exchange dates with someone if you can not be at church on your assigned Sunday. Thanks you for your help and cooperation.**

Stated meeting of the Session was held in the Frank Jones class room. Eight Elders present, one excused. Also present were 3 members of the Celebrate Recovery Evaluation Team. Rev. Thomas, moderator, opened the meeting with prayer.

B.B. Haigler presented the devotion.

Celebrate Recovery Evaluation Team members shared information on the structure of that program. Questions were asked and discussion followed. Session will decide whether to implement this program at a later date.

Rev. Thomas shared with the Session:

From the book Twelve Keys to an Effective Church, Alisa Wilhelm summarized Key 11 and Rev.

Thomas had Key 12. Discussion followed concerning how each Key related to Bethlehem.

B. Our current church devotion booklet, *These Days*, will be replaced by *Our Daily Bread* during 2011. The congregation's volunteer job list will be forth coming soon.

### Ministry Team Reports:

Finance: Through December 14, our treasurer's balance was minus \$7,980.79. A new heat/ac unit was installed in the Fellowship Hall by Cole's Comfort Contractors from Locust. Cost was \$4882.00. Congregation was asked to donate funds to cover the cost and so far \$2172.00 has been donated.

Christian Education: Bible School for 2011 will be August 1 – 4. Adult Sunday School Classes may use materials correlated with the youth material.

Mission and Service: Several Bethlehem members volunteered at Samaritan's Purse Warehouse in Charlotte in December and 150 shoe boxes were sent from our church. Canned goods, toys, blankets, coats and other items were donated by Bethlehem congregation and the youth and some leaders took these items to Tazewell, Tennessee as a mission project. Thanks to church members, leaders and youth for the huge success of this outreach program.

Preschool: Christmas program was December 15 at 11:00 a.m.

Worship: December 18 – Scout breakfast at church  
December 24 – Christmas Eve Service  
December 26 – One service, sanctuary, ordination/installation of new Elders

Next Session meeting – January 11, 2011 in Jones Class, 7:00 p.m.



We have recycled a total of 1,717 bottle lids to date. Keep up the good work!

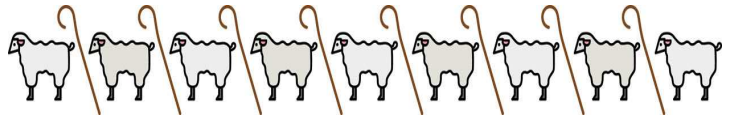

### Brand new

I am the new year. I am an unspoiled page in your book of time.

I am your next chance at the art of living. I am your opportunity to practice what you have learned about life during the last 12 months.

All you sought and didn't find is hidden in me, waiting for you to search it but with more determination. All the good you tried for and didn't achieve is mine to grant when you have fewer conflicting desires.

All you dreamed but didn't dare to do, all you hoped but did not will, all the faith you claimed but did not have — these slumber lightly, waiting to be awakened by the touch of a strong purpose.

I am your opportunity to renew your allegiance to him who said, "See, I am making all things new" (Revelation 21:5, NRSV).

—Author unknown

**"The highest reward for a person's toil is not what they get for it, but what they become by it."**  
—John Ruskin



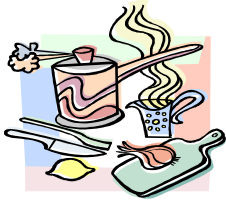

## Recipe for a Happy New Year

Take 12 whole months; remove all bitterness, hatred and jealousy. Wash them in love, light and life.

Then cut each into 28, 30 or 31 pieces, as desired. Set aside all but one portion. Prepare the daily portion, one day at a time, by adding the following ingredients: 1 part faith, 1 part patience, 1 part courage and 1 part honest work. Mix well.

Add to each day 1 part hope, faithfulness, generosity and kindness. Blend with 7 parts prayers and 3 parts mediation. Add at least 1 good deed.

Season with whole with a dash of good spirits, a sprinkle of fun, a pinch of play and a cup of good humor. Carefully fold in friends and family until thoroughly combined.

Pour all ingredients into a vessel well oiled with harmony. Cook thoroughly over radiant accord until your heart tests warm and tender. Garnish with a smile and serve with quiet unselfishness and unending happiness.

**Yield:** a Happy New Year filled with joy, peace, hope and love.

Submitted by Pat Sloan from Country Women Magazine—December/January 2011 issue

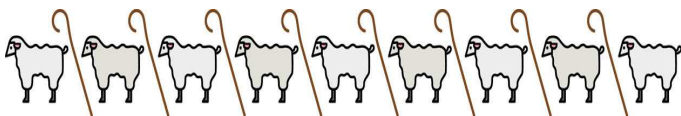

### Missing pronouns

You cannot pray the Lord's Prayer and even once say I.

You cannot pray the Lord's Prayer and even once say my.

Nor can you pray the Lord's Prayer and not pray for one another,

To ask God for "our" daily bread, you must include your brother.

For others are included ... in each and every plea,

From the beginning to the end of it, it does not once say me.

The Building and Grounds Ministry Team wants to thank everyone for their additional support of financing for the heating unit in the fellowship hall and kitchen. The 21 yr. old unit did serve us well and for that we are grateful. Cole's Comfort Contractors of Locust, did us a good job installing the unit and they have been very nice to work with on some other minor jobs. Over all, I think the physical part of our Church is in good shape and hopefully we will not have any major financial needs in 2011!!!!!!!!!!!!!! We are hoping to get a natural gas supply in the near future.

Thanks,  
Building & Grounds MT

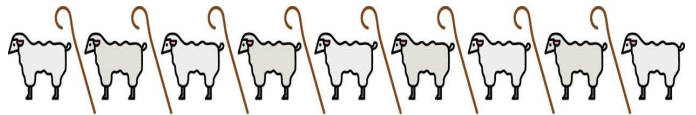

Thank you Advent Readers for adding to the worship experience during Advent.

### Advent Lay Readers

#### 8:45 am Service

November 28th—Danny & Gayle Phileman

December 5th—Alisa Wilhelm's family

December 12th—Scott Cuthbertson's family

December 19th—Mike McConnaughey's family

#### 11:00 am Service

November 28th—George & Pat Sloan

December 5th—Phyllis Thomas & Louise Mullis

December 12th—Johnny & Carolyn Gordon

### Christmas Eve - The Shumate Family



Thank you Church for my lovely Christmas bonus. It is hard to believe I've been here 12 years and can say with all sincerity I love my job! Thank you for allowing me to serve the Lord with you from this place.

Linda



# YOUTH NEWS

www.bethlehemchurch.net/youth

## JANUARY 2011

discipleship worship membership stewardship friendship

### Steward-whaa?

Why my time, talents & money matter.

**H**ow am I supposed to give money to the Church if I don't even have a job? It's a good question and you're not alone in asking it. So, why do we even include stewardship in our 5 BYG Ships? Because stewardship is more about **attitude** than it is about your stuff.

How did you spend your last 24 hours? Everyone was given the same thing:

**1 day**  
**1440 minutes**  
**86400 seconds**

No matter how you measure it, it is yours to use however you choose. Sure you may not *choose* to go to school, but how do you use the time you have there? Where else can you improve the way you use your time?

Time, just like money and talents, are gifts we've been given from God. How we use them reflects our **relationship** with God. What does it say about who we are if we use all our gifts only for ourselves? What does it say about our relationship with God if none of our gifts are used to bring honor to Him?

Think about your time this week. Do you share it with friends? Will you help someone in need? Will you spend any time alone with God?

### over **flow** faith. hope. love.



great job mission team!  
179 fed, over 60 children with toys!

### BYG Theme 2010-2011 **inside out**

download "From the Inside Out" by Hillsong United on iTunes or check it out on YouTube

winter/spring  
**KICK-OFF**



**flip your  
lid**

january 2 @ 6pm  
the byg house

Whether it's a ballcap or a babushka, wear your favorite, most unique headgear and come for games, discussion, skits, etc. Everyone please bring a finger food to share.

parent meeting included



**SUNDAY  
SCHOOL**

with Chad

*sundays @ 10am*

bring change.

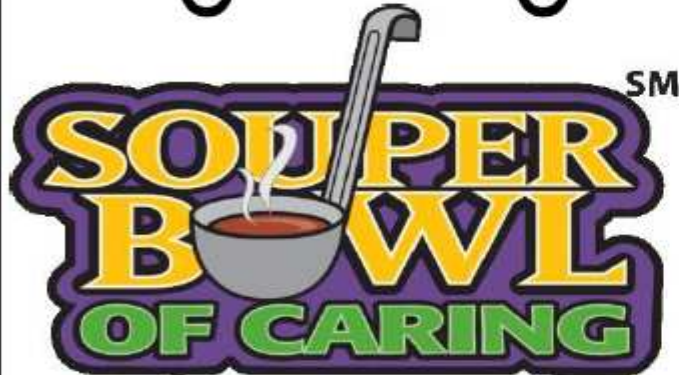

02.06.11

**sundaynights**

youth fellowship 6-7:30pm

1.2.11 Winter/Spring Kick-off, 6pm  
Parent Meeting

1.9.11 Youth Fellowship, 6pm  
"Raising the Bar: More Than I  
Have Become"

1.16.11 Youth Fellowship, 6pm  
"Stumbling Blocks"

1.23.11 Youth Fellowship, 6pm  
"In this Together"

1.30.11 Youth Fellowship, 6pm  
"Art of Losing Myself"

If you have ideas that you'd like to discuss one night in youth fellowship, please email Andy.

**See you Sunday at the BYG House!**

Upcoming Events

**January**

- 2 Youth Kick-off
- 9 Youth Fellowship
- 16 Youth Fellowship
- 23 Youth Fellowship
- 30 Youth Fellowship

**February**

- 6 SOUPER Bowl of Caring  
Super Bowl Party
- 13 Youth Fellowship
- 20 Youth Fellowship
- 27 Youth Fellowship

More updates can be found at  
[www.bethlehemchurch.net/youth](http://www.bethlehemchurch.net/youth)

To receive a weekly update email, send your email  
address to Andy at  
[youthdir@bethlehemchurch.net](mailto:youthdir@bethlehemchurch.net)

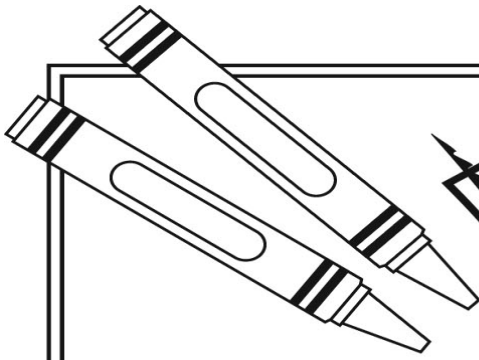

# PUZZLE

## From darkness to light

In the Bible, God speaks often about light and darkness. He gives us much instruction about which path we should choose.

- |           |               |
|-----------|---------------|
| 1. Good   | Righteousness |
| 2. Death  | Children      |
| 3. Go     | Life          |
| 4. Evil   | Come          |
| 5. Adults | Bad           |



Match the opposites and then write the word in the right-hand column in the correct blanks to finish each verse.

“When your eyes are good, your whole body also is full of light. But when they are \_\_\_\_\_, your body also is full of darkness.” Luke 11:34, NIV  
(1)

“I am the light of the world. Whoever follows me will never walk in darkness, but will have the light of \_\_\_\_\_.” John 8:12, NIV  
(2)

“I have \_\_\_\_\_ into the world as a light, so that no one who believes in me should stay in darkness.” John 12:46, NIV  
(3)

“For what do \_\_\_\_\_ and wickedness have in common? Or what fellowship can light have with darkness?”  
2 Corinthians 6:14, NIV  
(4)

“For you were once darkness, but now you are light in the Lord. Live as \_\_\_\_\_ of light.” Ephesians 5:8, NIV  
(5)

Answers: 1. bad, 2. life, 3. come, 4. righteousness, 5. children

Bethlehem Presbyterian Church  
7608 Concord Highway  
Monroe, North Carolina 28110  
(704) 753-4223  
www.bethlehemchurch.net

Warm winter blessings to...

# St r of Bethlehem

## Bethlehem Presbyterian Church

### Mission:

To glorify God  
by leaving a legacy of faith  
to succeeding generations through  
the proclamation of the good news of Jesus  
in word and deed,  
by the power of the Holy Spirit.

### We will accomplish our mission by:

**Abiding in Christ** - *I am the vine, you are the branches. Those who abide in me and I in them bear much fruit, because apart from me you can do nothing* - John 15:5

We are a community of believers who seek to dwell in the presence of Jesus and who strive to grow into maturity in our relationship with God in Christ. We will encourage others to do the same.

**Loving Others as Christ** - *This is my commandment, that you love one another as I have loved you. No one has greater love than this, to lay down one's life for one's friends.* - John 15:12-13

We are a community of believers who seek to respond to Jesus' grace in our lives by loving others with his love.

**Inviting others to Christ** - *"Everyone who calls on the name of the Lord shall be saved." But how are they to call on one in whom they have not believed? And how are they to believe in one of whom they have never heard? And how are they to hear without someone to proclaim him? And how are they to proclaim him unless they are sent? - Romans 10:13-15a* Go therefore and make disciples of all nations, baptizing them in the name of the Father and of the Son and of the Holy Spirit, and teaching them to obey everything that I have commanded you. And remember, I am with you always, to the end of the age. Matthew 28:19-20

We are a community of believers who blessed by the presence of Jesus and provision of God the father will invite all those within our sphere of influence into the saving presence of Jesus.